

AIR TOWEL® 50 years' technology
devoted in hand dryers

KTM120 / 120UV

Air Towel Hand Dryer

Instruction Manual



SAFETY

- ※ Read this manual carefully before using this product.
- ※ Follow the warnings and cautions on this page to ensure correct and safe use. Disregarding warnings and cautions may result in personal injury or product damage.

Warning

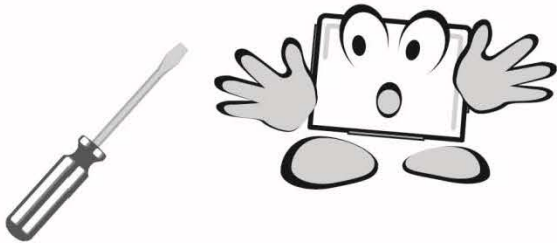

 **Do not disassemble, repair or modify the product.**

Disassembly, repair or modification may cause the product to ignite or cause a malfunction resulting in fire or electrocution.

- ※ To repair the product, contact the dealer from whom you purchased the product.

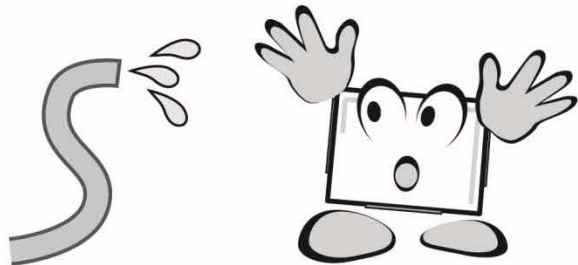

 **Do not subject the product to liquids.**

A short-circuit or fire may occur or you may receive an electric shock if the product is wet.

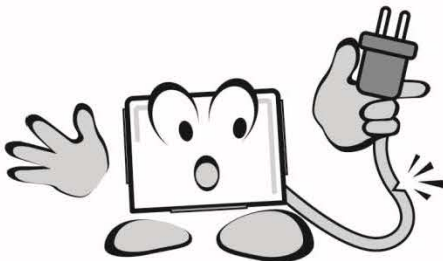

 **Do not tamper with the power cable or plug.**

- ※ Do not damage or modify the power cable or plug
- ※ Do not place the cable or plug near an appliance that emits heat
- ※ Do not excessively bend, twist or pull on the cable or plug
- ※ Do not place heavy objects on the cable and plug
- ※ Do not incorrectly bind the cable or plug
- ※ Doing any of the above may result in a short-circuit, electrocution or fire.
- ※ To repair the cable or plug, contact the dealer from whom you purchased the product.

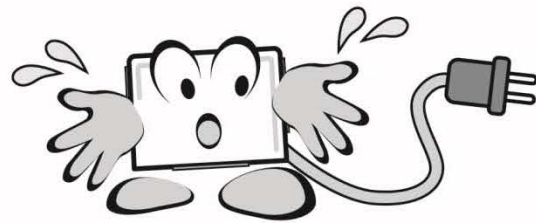

 **Do not touch the power plug with wet hands—there is danger of electrocution.**

- If the plug is covered with dust, it may absorb humidity, causing insufficient insulation and resulting in a fire.
- ※ Clean the plug by disconnecting it from the power source. Wipe and clean with a dry cloth.
- ※ If you will not be using the product for long periods, disconnect the power plug from the power source.

The symbols shown on this page define the warnings and cautions.

 **Warning** Not following the warning may result in death or serious injury.

 **Caution** Not following the caution may result in personal injury or product damage.

The following symbols define the seriousness of the danger or potential product damage if used incorrectly.

-  Do not do this.
-  Follow the instruction.

Cautions on product use

- Do not use the product in environments with high temperatures (40°C or more), where humidity is high or excessive steam is generated.
These conditions may cause the product to deform or malfunction.
- Do not close or cover the air intake or exhaust openings.
This may cause the product to malfunction.
- Do not use the product to dry hands that have been exposed to chemicals.
The chemicals may adhere to the product and may cause a malfunction.

⚠ Notice



- ⊘ Do not hang on the product-you may slip and fall and injure yourself.

Do not place anything on the product-the object may fall to the floor and you may be injured.



- ⚠ Hold the power plug firmly when disconnecting.
Do not pull on the cable when disconnecting.

Pulling on the power plug may damage the cable, resulting in a short-circuit or fire or you may be electrocuted.



- ⊘ Do not insert foreign objects such as pins, wires or metal into the air exhaust opening or any other opening-doing so may result in electrocution.

- ⚠ **Make sure the power plug is firmly connected.**

If not correctly connected you may be electrocuted or heat generation may cause a fire.

* Do not use a damaged or loose plug.

- ⚠ **Use single-phase alternating current 120V (for KTM120 / 120UV).**

Do not use the product with other appliances sharing the same power source-the heat generated may cause a fire.

- ⚠ **Unplug the power plug from the power source when maintenance is required.**

(If the product is connected to a dedicated power source, turn off the earth leakage breaker.)

If you perform maintenance on the product while the power plug is connected to the power source, the product may accidentally turn on and you may be injured or electrocuted.

- ⚠ **Make sure an earth leakage breaker is installed at the power source.**

If an earth leakage breaker has not been installed, you may be electrocuted when the product malfunctions or current leakage occurs.

AIR TOWEL® KTM120 / 120UV
Manual of Operating Instructions

Names and dimensions

Specifications

Voltage / Frequency	Airflow	Power consumption	Weight	
Single-phase 120V, 50~60Hz	High	Hot air ON 920W	4.7kg	Main body material:ABS resin Main body color:White Power cable:1.8m(AC 125V plug)
		Hot air OFF 690W		

Construction



Main body

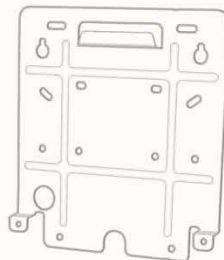

Mounting board



Screw $\varnothing 4 \times 14L$ 2EA
Screw $\varnothing 4 \times 16L$ 6EA



Anchor plug $\varnothing 4 \times 16L$ 6EA



Water block | Water cup

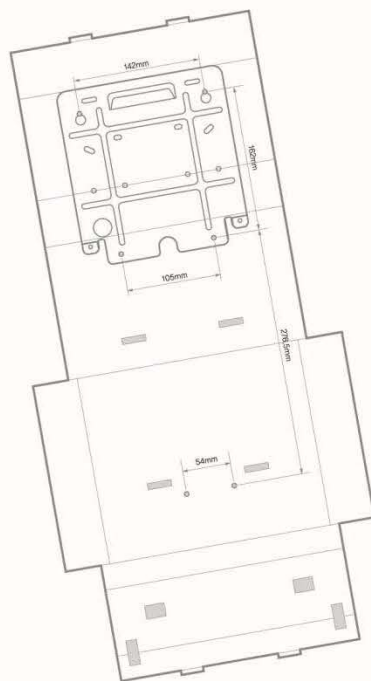

Mounting surface guiding sheet
(packaging board)



Opener 1EA
(Attach to the bottom of the
downspout and keep it that way.)



HEPA Filter (separated sold)
If you order HEPA Filter, HEPA Filter will be the
basic filter that comes with your products.



Manual

Front View | Side View (Unit : mm)

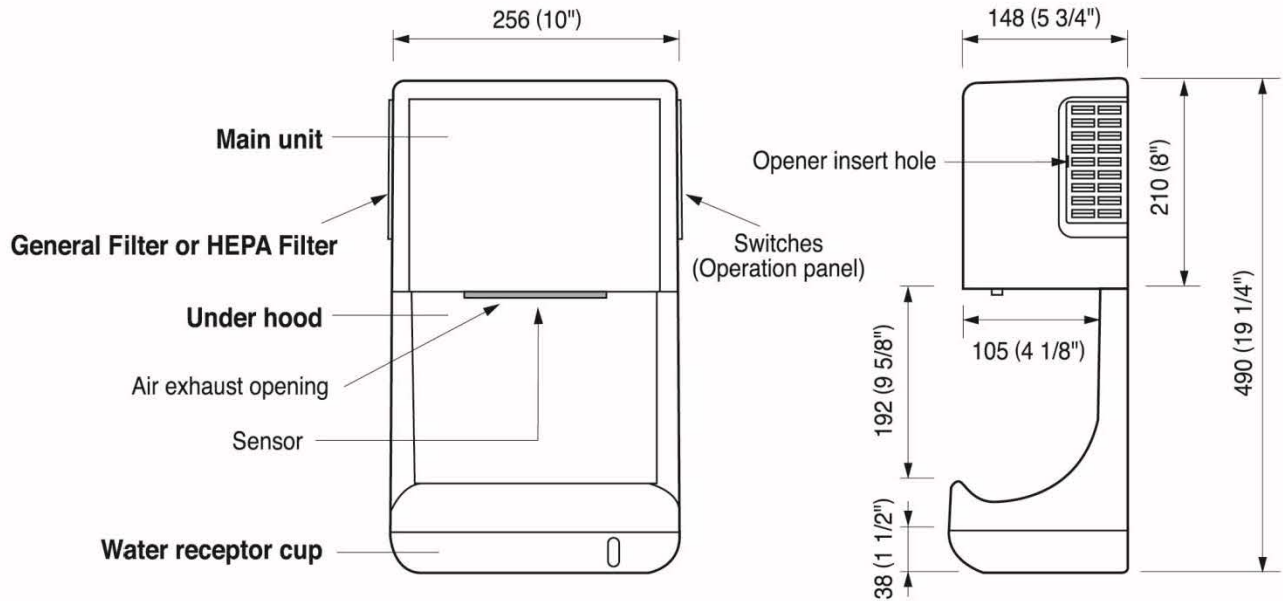

Installation | Switches (Operation)

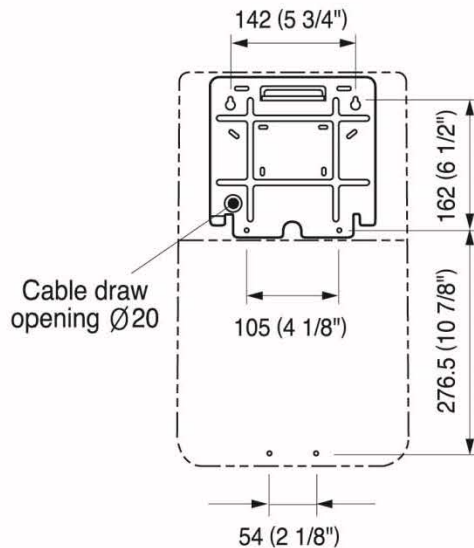

Wood screw, Anchor plug ϕ 3.8×20mm (7/8") (6)
Tapping screw ϕ 4×12mm (1/2") (2)

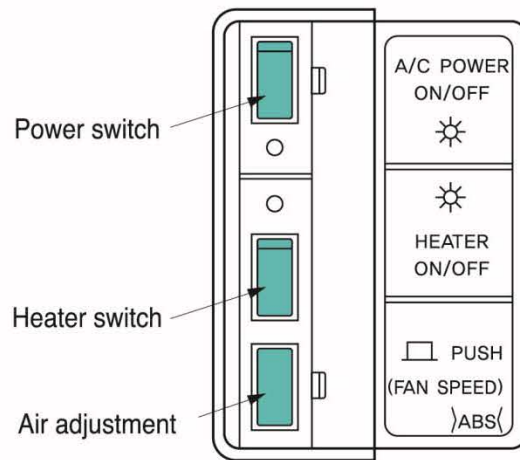

Pressing the button changes the air flow
(High→Low→Medium)

Preparations before Installation

Attaching Face Guide Sheet
(Product Packaging Cardboard)

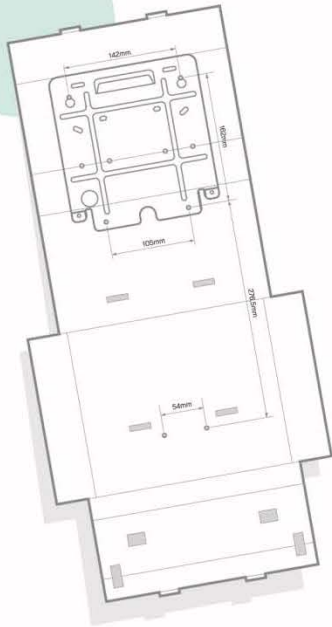

1 Locate the position to install the Air Towel.

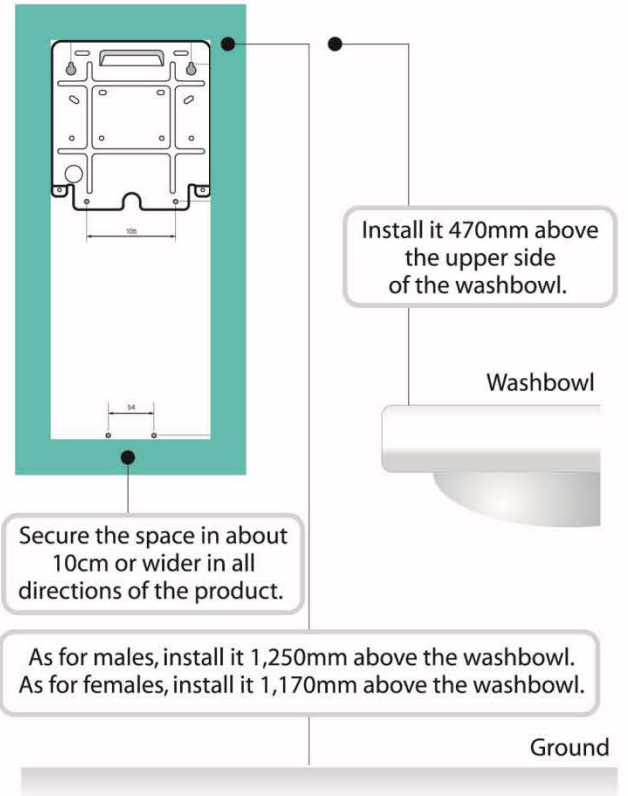

2 Attach the Attaching Face Guide Sheet to the area to install the Air Towel temporarily with an adhesive tape. Mark the area with a pen and install it with an anchor plug.

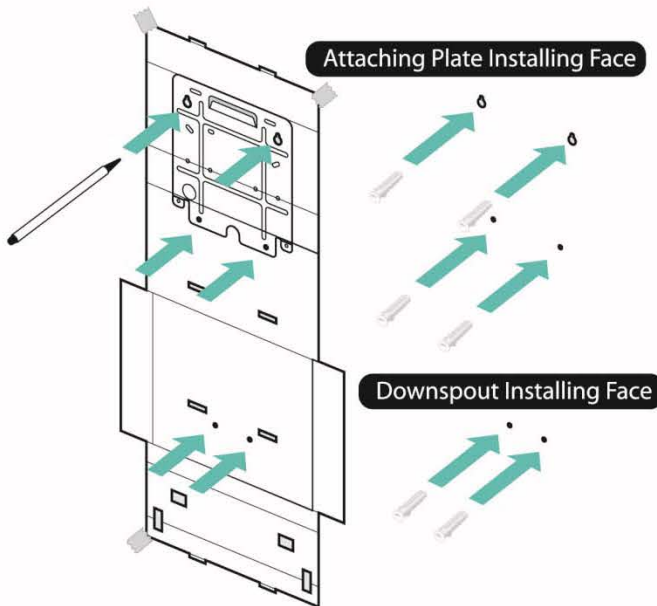

3 Detach the Attaching Face Guide Sheet and fasten the Attaching Plate to the Installing Face with screws.

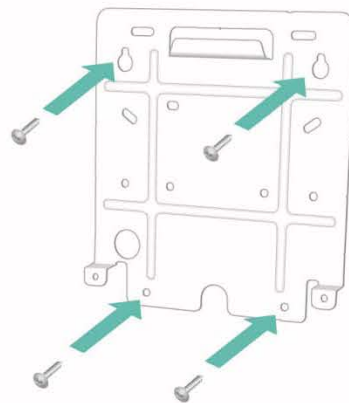

Install the main unit

- 1** Take out the two $\varnothing 4 \times 10L$ bolts on the front cover.

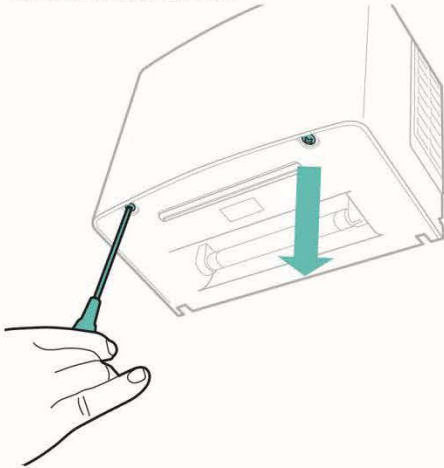

- 2** Pull the front cover ahead lifting it up.

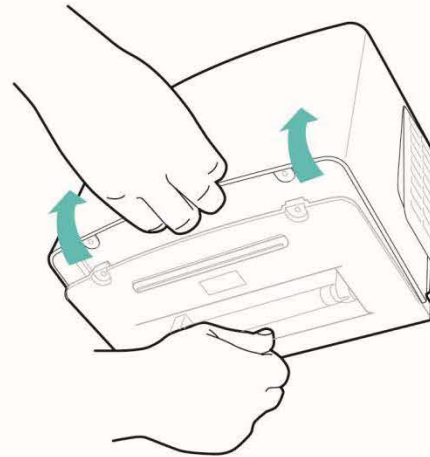

- 3** Connect the mounting board with the back plate set.

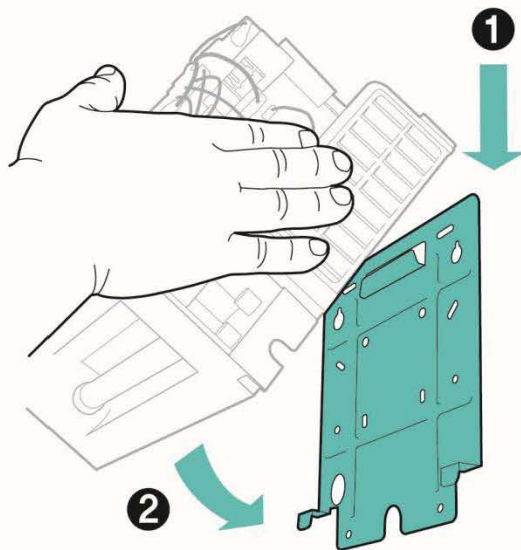

► Connect them from above and check if a clicking sound is given when it is pressed from below.

- 4** **In case the cables are protruded unnecessarily out of the main body**

Adjust them according to the installation position. Then Fasten them with the use of a cable tie.

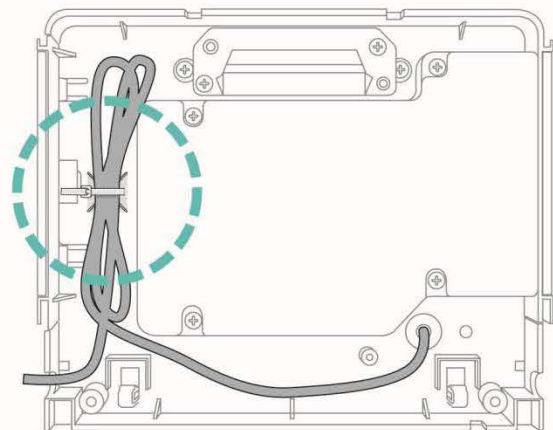

Removing the main unit from the wall

1. Remove the cover (2 screws)
 2. Push the pawls (2) (in the lower side of the main unit) down. Pull the main unit up and out to detach from the installation board.
- ※ Before removing the main unit from the wall, disconnect the power plug (dedicated power cable)

Install the Water Receptor

5 Separate the water tank

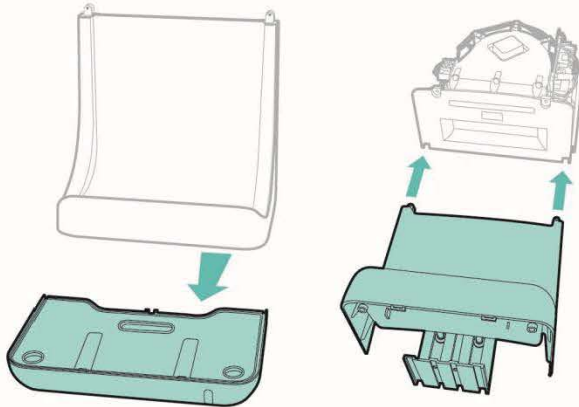

6 Bolt the back plate with the water tank's connection parts.

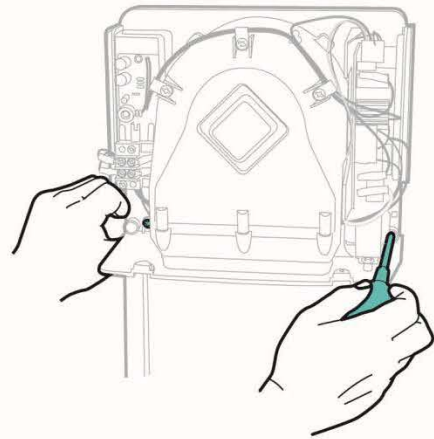

7 Insert the wood screws (provided) in the holes located at the lower part of the water receptor unit. Install the water receptor cup to the main unit.

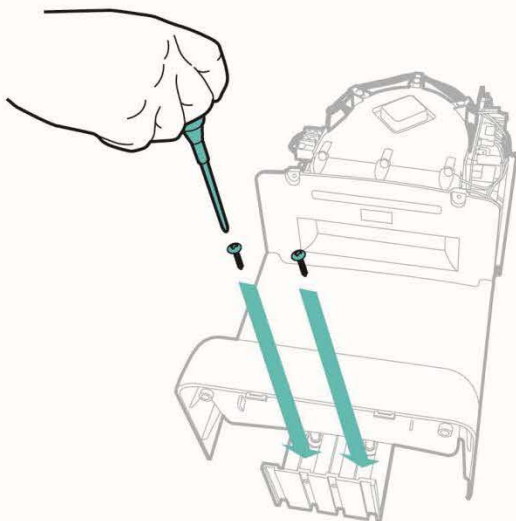

8 Connect the front cover from above. Fasten the two $\varnothing 4 \times 10$ L bolts on the front cover.

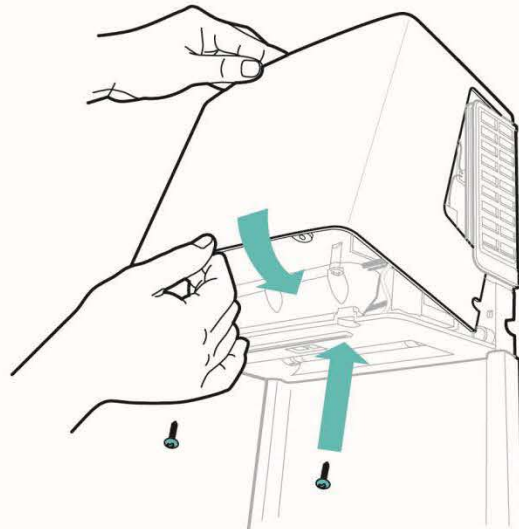

Test

Connect the power plug to the power source or turn on the breaker (if a dedicated power source is being used.)

- 1 Open the switch box cover with the opener. Turn on the power switch. Make sure that the power lamp turns on.
※ To open the operation panel (Switch box), use the metal jig provided with the product.

- 2 Make sure the product starts when you put your hands under the air blow hole and stops when you remove your hands. See if the hand is sensed 110mm below the sensor .

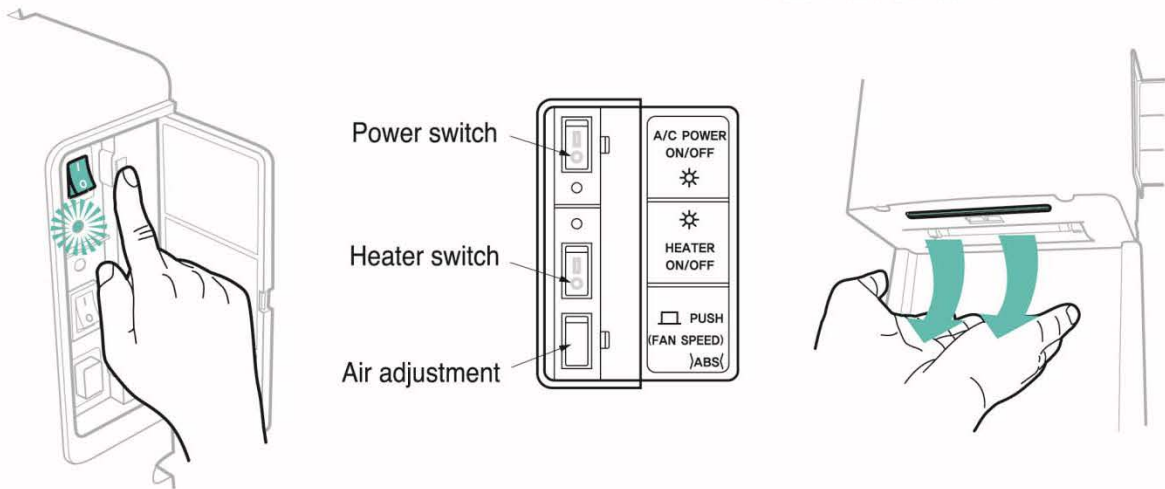

Connecting the product to a dedicated power cable

1. Remove the cover (2 screws)
2. Insert the dedicated power cable into the power cable hole in the installation board. Pull the power cable into the main unit.
3. Hook the top part of the main unit on the installation board, push in the main unit until you hear a locking sound that indicates it has been firmly installed.

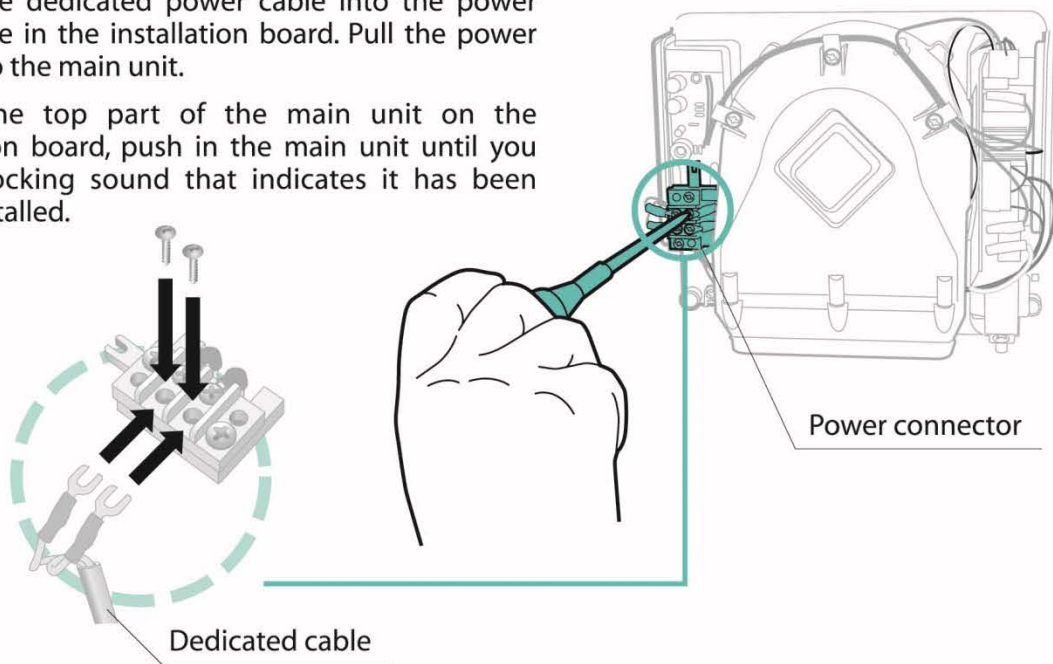

Maintenance

How to set the Air Towel Sensor (operating distance reception adjustment)

1. Install the device in your workplace and open the cover of the switch box.
2. Turn the heater switch on. The switch is in the middle of the switch box.
3. With the push button switch which is in the lower part of the switch box pressed, turn the power switch on. The motor will rotate for 1 to 9 seconds, adjusting the reception of the sensor.

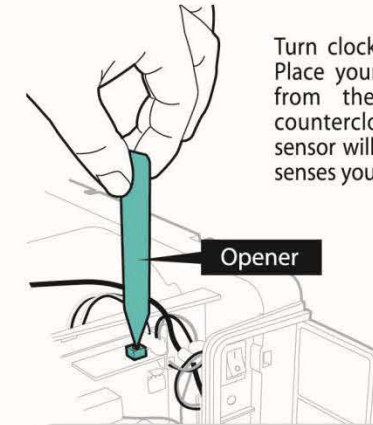
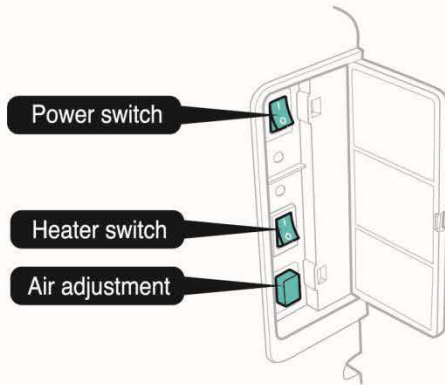

Turn clockwise until it is tight. Place your hand 110mm away from the sensor and turn counterclockwise slowly. The sensor will stop the product if it senses your hand.

- ↻ Clockwise - the sensing length shortens.
- ↻ Counterclockwise - the length extends.

Cleaning the filter (Once or twice a month) and Removing the water from the Drain tray

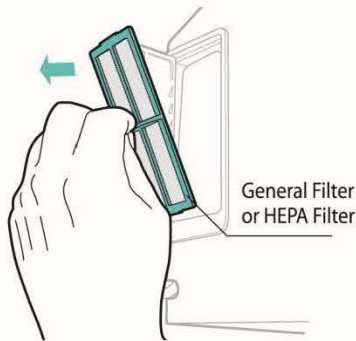

Open the filter box cover with the opener.

Filter replacement

(Depending on the condition of the installed place, it needs to be changed in about every one to six months.)

※ If the filter is not clean, the air blow force will decrease, requiring a longer time to dry the hands.

1. Remove the filter from the main unit.
※ To open the filter box, use the metal jig that has been provided.
2. Clean filter
※ If the filter is excessively dirty, wash it with a mild detergent. Dry the filter completely.
3. Install the filter back into the main unit.
※ Make sure the filter has been securely installed. You will hear a clicking sound after it has been locked into position.
4. Clean filter
※ Check the cleanliness every week. Clean the dust once a month without using water. Just dust it off.

Water receptor cup replacement

1. Remove the water receptor cup from the main unit.
2. Remove the top cover from the water receptor cup. Dump out the water.
※ Wash and clean the cup if necessary using mild detergent.
3. Replace the top cover. Install the water receptor cup to the main unit.

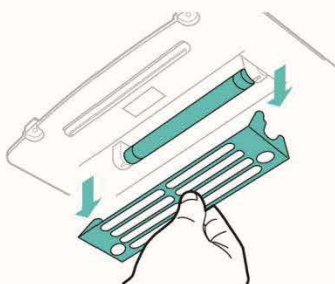

Lamp replacement

1. Cut power.
2. Remove the lamp protection cover.
3. Turn the lamp of the main body slightly. 90°
4. Remove the lamp from the main body and connect a new one.
5. Supply power and check the lamp by putting your hand on the sensor window.
6. Connect the lamp protection cover.

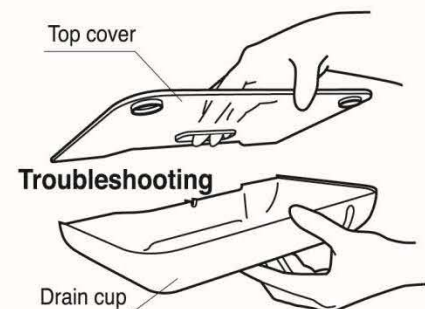

Problem solving

I Power supply failure I

Check power cord insertion.

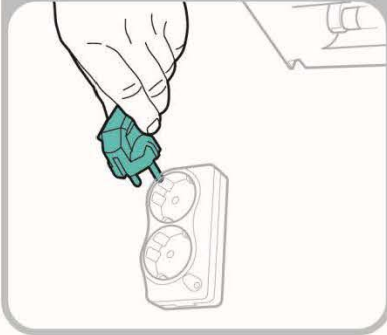

Check the power switch and lamp.

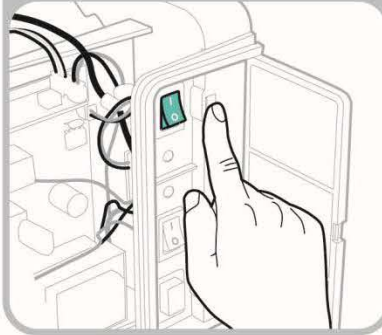

Check if the circuit breaker is on.

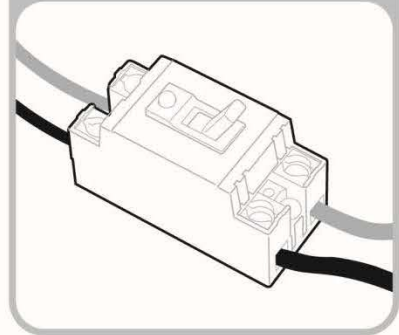

I Functioning without detection I

Check if the sensor is in place.

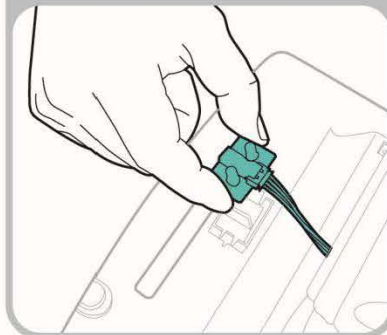

Volume control

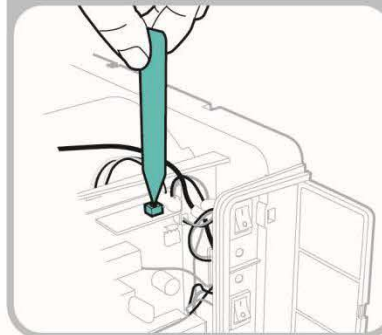

Sensor window cleaning

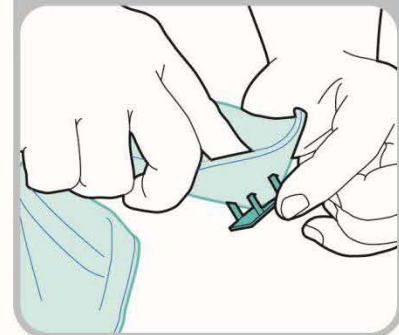

I Weak wind I

Filter cleaning

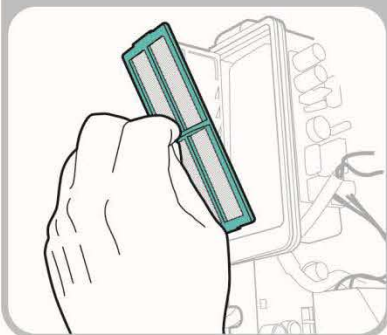

Adjust with the speed control switch.

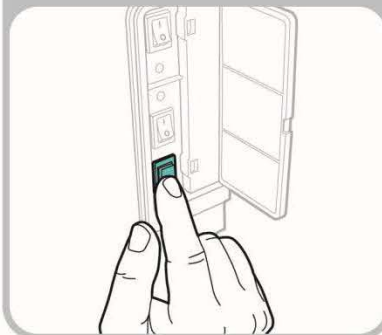

• If the problem persists, turn off the power switch, and contact dealer you purchased the product.

Warranty

Date of purchase.

MODEL	 KTM120 / 120UV
-------	--

Customer	Address	
	Tel	
	Name	

Warranty period : 5 years
(motor and other small parts are excluded)

Dealer / Name, Address, Telephone Number



This product has been manufactured under the highest quality control and shipped after thorough inspection. If the product fails even after being used correctly, it will be repaired free of charge in accordance with warranty policy.

Warranty policy

- If the product fails even after being used correctly, it will be repaired free of charge 5 years after the day of purchase.
- The product can be repaired for a fee in the following cases:
 1. The product has failed or has been damaged through incorrect use or has received unauthorized repair or modification.
 2. The product has failed or become damaged because of fire, earthquake, flood, abnormal climate conditions, incorrect power supply or other natural disasters.
 3. The product has failed or become damaged because it was transported, moved or dropped after purchase.
 4. The Warranty Card has not been presented.
 5. No information has been written on the Warranty Card or the information on the Warranty Card has been modified.

[Note]

1. Please verify that the correct information (i.e., dealer name, date of purchase, etc.) has been entered on the Warranty Card.
2. If you request a repair under the warranty, present the Warranty Card to the dealer you purchased the product.
3. The Warranty Card cannot be reissued. Store the Warranty Card in a safe place.

